

Fuzzy Logic Controller Deployed for Indoor Room Temperature Control

Phyu Phyu Lwin
Computer University (Pyay)
phyuphyulwin.86@gmail.com

Abstract

Fuzzy logic is widely used in machine control. Although genetic algorithms and neural networks can perform just as well as fuzzy logic in many cases, fuzzy logic has the advantage that the solution to the problem can be cast in terms that human operators can understand, so that the experience can be used in the design of the controller. In this system, distributed temperature sensors are used inside the room to measure inputs to the fuzzy system. Sensors' signals are taken as inputs to the microcontroller in fuzzification process. PIC16F877 microcontroller is used to control the system. The controller output can decide the fan operation.

1. Introduction

Temperature is one of the important factors of living creatures to survive. If the temperature is high or low beyond the limits, it can affect the life of living things. As in human being, other materials need to limit their own to survive. Probably the most important no electrical parameter that affects the performance of an electronic component is its temperature. At low- temperature extremes, a device may fail to function because the change in temperature has significantly altered the electrical characteristics of the materials from which it is made.

The number of people inside indoor environment at the same place plays an important role in this issue, where natural ventilation such as windows, doors, and ventilation shafts should be able to refresh the air inside any closed area by removing the poisonous gases and replace them with fresh air which is allowed to enter from outside through the joints and gaps in the windows and doors which contains the necessary amount of oxygen to survive, this process should take place more than once during the day to refresh and replace the air for the indoor environment.

Natural ventilation could also keep the room at good climate by removing humidifying air, odors and other harmful substances from the rooms. In fact, natural ventilation does not work fine all the times, especially during winters or cold climates where most of the available resources for natural ventilation are decreased by insulation of these joints and gaps to keep good thermal climate inside the indoor environment.

2. Background Theory

2.1. Fuzzy Logic in Control System

A fuzzy controller consists of a set of linguistic rules expressing the control policy of the process operator. The validity of this method is supported on the fact that the control of some processes by a human operator achieves better results than the controllers based on mathematical models [1].

In many applications of fuzzy control system, fuzzy if-then rules are heuristically obtained from human experts. How to systematically, rather than heuristically design and justify a fuzzy controller has been proved to be an extremely challenging problem for design and analysis of fuzzy control system. Recently, several different methods to design and analyze fuzzy controller have been proposed.

Fuzzy logic control has been rapidly gaining popularity among practicing engineers. As opposed to the modern control theory, fuzzy logic design is not based on the mathematical model of process. The real world is complex; complexity in the real world generally arises from the uncertainty in the form of ambiguity have been addressed subconsciously by humans since they could think; these features pervade most social, technical, and economic problems faced by the human race [3].

2.2. Fuzzy Control System

A fuzzy system is any system whose variables range states that are fuzzy sets. The fuzzy sets are fuzzy numbers, and the associated variables are linguistic variables. The inputs and outputs are crisp numbers which are not fuzzy numbers. The inference uses the fuzzy rules in the rule base to produce fuzzy conclusions and the defuzzification process converts these fuzzy conclusions into the crisp outputs.

The fuzzy control system consists of:

1. The rule-base holds the knowledge, in the form of a set of rules of how to best to control the system.
2. The inference mechanism evaluates which control rules are relevant of the current time and then decides what the input to the plant should be.

3. The fuzzification interface simply modifies the inputs so that they can be interpreted and compared to the rules in the rule base.
4. The defuzzification interface converts the conclusions reached by the inference mechanism into the inputs to the plant [7].

3. Microcontroller

Microcontroller is a single chip computer. Micro suggests the device is small and controller suggests that device can be used in control application. Another term for microcontroller is called embedded controller. PIC16F877A is the famous embedded controller [2].

3.1. Hardware Overview of PIC16F877A

The PIC 16F877A has 5 digital I/O ports (A-E) each between 3 and 8 bits wide. Each port is mapped into the register file space, and may be read / written to like any other register. The circuitry is such that it is not possible to physically input to and output from a particular pin simultaneously. For most ports, the I/O pins direction (input or output) is controlled by the data direction register, called the TRIS register. TRIS<x> controls the direction of PORT<x>. A "1" in the TRIS bit corresponds to that pin being an input, while a "0" corresponds to that pin being an output. An easy way to remember is that a "1" looks like an "I" (input) and a "0" looks like an "O" (output).

PIC16F877A has 5 digital I/O ports; there are PORTA, PORTB, PORTC, PORTD and PORTE. PORTA is a 7-bit wide, bi-directional port. The pin functions of 5 I/O ports are showed in Appendix. The corresponding register is TRISA. PORTA is multiplex with analog input and timer. PORTB is an eight-bit wide, bi-directional port and the corresponding data register of it is TRISB. PORTC is also eight-bit wide, bi-directional and the corresponding data register is TRISC. PORTD is an eight-bit port with Schmitt Trigger input buffers. PORTE has three pins which are individually configurable as inputs or outputs. The pin output diagram of PIC16F877A shown in figure 1 [2].

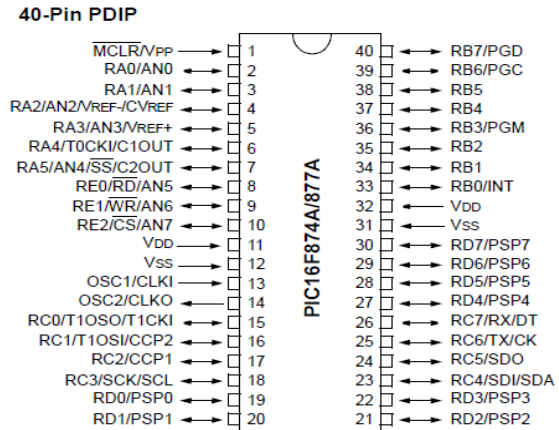

Figure 1. Pin Diagram of PIC16F877A [2]

3.2. Fuzzification

Fuzzification can be defined as the operation that maps a crisp object to a fuzzy set to a membership function. The input variables in a fuzzy control system are general mapped into by sets of membership functions similar to this, known as fuzzy sets. The process of converting a crisp input value to a fuzzy value is called "fuzzification" [4].

Form the output of the system, the temperature can be sense and the fan speed can be measured. Both of these are precise numbers. Fuzzification is the process of obtaining a value of an input variable and finding the numeric value of the membership functions that are defined for those variables. The membership function value is an "encoding" of the fuzzy controller numeric input values. The encoded information can then be used in the fuzzy inference process [5].

3.3. Fuzzy Inference Rules

The rule development strategy for systems with time delay is to regular the overall loop gain to achieve a desired step response. The output of the FLC is based on the current input temperature and fan speed without any knowledge of the previous input and output data or any form of model predictor. The main idea is that if the FLC is not designed with specific knowledge of mathematical model of the plant, it will not be dependent on it. Fuzzy sets that obtained from the fuzzification are matched with the fuzzy set in the rule base. An output fuzzy set of each active is given from the rule base.

Table 1. Rule Base for new fan speed output

Temp \ Fan speed	N	NW	W	WH	H	VH	VVH
VVS	VVS	VS	S	M	L	VL	VVL
VS	VVS	VS	S	M	L	VL	VVL
S	VVS	VS	S	M	L	VL	VVL
M	VVS	VS	S	M	L	VL	VVL
L	VVS	VS	S	M	L	VL	VVL
VL	VVS	VS	S	M	L	VL	VVL
VVL	VVS	VS	S	M	L	VL	VVL

3.4. Inference Mechanism

Fuzzy sets that obtained from the fuzzification are matched with the fuzzy set in the rule base. An output fuzzy set of each active is given from the rule base. μ values of each fuzzy set are obtained from fuzzification. These μ values are operated by using the minimum and maximum methods to get the μ_{max} value is searched and converted into the defuzzification. The fuzzy inference mechanism follows as

$$\mu_B(y(t)) = \max[\min[\mu_{A1}(T(t)), \mu_{A2}(F(t))]] \quad (3.1)$$

Where $\mu_{A1}(T(t))$ is the membership function of $T(t)$, $\mu_{A2}(F(t))$ is the membership function of $F(t)$, $\mu_B(y(t))$ is the membership function of $y(t)$ [6, 7].

3.5. Defuzzification

Defuzzification operates on the implied fuzzy sets produced by the inference mechanism and combines their effects to provide the most certain controller output. Some think of defuzzification as decoding the fuzzy set information produced by the inference process into numeric fuzzy controller output.

With "Center of gravity (COG)" defuzzification method, the process for combing the recommendation represented by the implied fuzzy sets from all the rules is excellent.

Fuzzy output $y(t)$ can be calculated by the center of gravity defuzzification as

$$y(t) = \frac{(\sum \mu_B(y(t)) * y_1)}{(\sum \mu_B(y(t)))} \quad (3.2)$$

If the output membership functions are not symmetric, their center which are needed in the computation of the COG, will change depending on the membership value of the premise, where have taken the implied fuzzy sets and simply added an indication of COG defuzzification is the best

representation of the conclusions reached by the rules are on drawn the output membership functions [8].

4. Design and Implementation

In the indoor room temperature control system, fuzzy logic is implemented to PIC 16F877A. PIC senses the inputs from sensors and controls the desire speed of the indoor air ventilations motor (DC motor). In the automatic air ventilations has two parts of implementations: hardware implementation and software implementation.

4.1. Hardware Implementation

In the indoor room temperature control system can be operate with the following parts temperature detecting system, DC motor, LCD (Liquid Crystal Display) and PIC 16F877A.

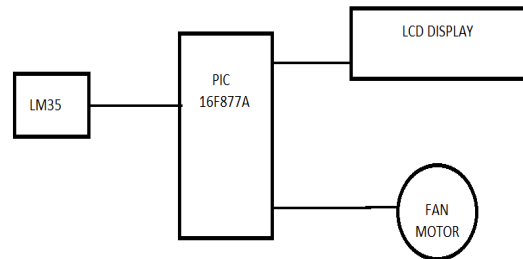

Figure 2. Block Diagram of indoor room temperature control system

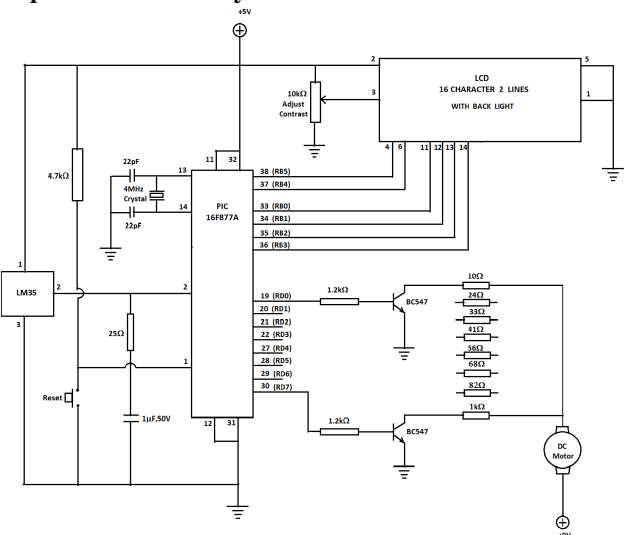

Figure 3. Overall Circuit Diagram of Indoor Room Temperature Control System

In the indoor room temperature control system, LM35DZ analog temperature sensor I.C is used for temperature sensor. Because the outputs of the sensor is analog signals, A/D converter in the Microcontroller (PIC 16F877A) is used to convert as

digital signal. In the PIC16F877A, AN0 pin is the input from temperature sensor.

This system controls the speed of DC motor with fuzzy logic by using PIC 16F877A. This PIC contains PWM and A/D converter. PIC16F877A has 5 I/O ports but indoor room temperature control system is used 3 I/O ports Temperature sensor is connected AN0 pin of PIC. Output of PIC is send from RD0-RD7 pin to DC motor driver circuit. LCD is connected with PORTB of PIC. This PIC has been operating as fast as for indoor room temperature control system using fuzzy logic control. Block diagram and overall circuit diagram of indoor room temperature control system is shown in figure 2 and 3.

4.2 Software Implementation

In the indoor room temperature control system will be implemented with PIC16F877A by using fuzzy logic control. In this system, temperature sensors is collected the environment data and send to PIC. PIC reads the sensors' data with built in A/D conversion and performs preprocessing step or scaling factor and normalization. And then fuzzification process and inference are performed. In this system membership functions are assigned with intuition method and orthogonal method or max_min method is used as inference. After, system obtains the output of defuzzification and postprocessing. In this system is used centre of gravity method (COG) as defuzzification process. The flow chart of automatic fire fighting system is shown in figure 4.

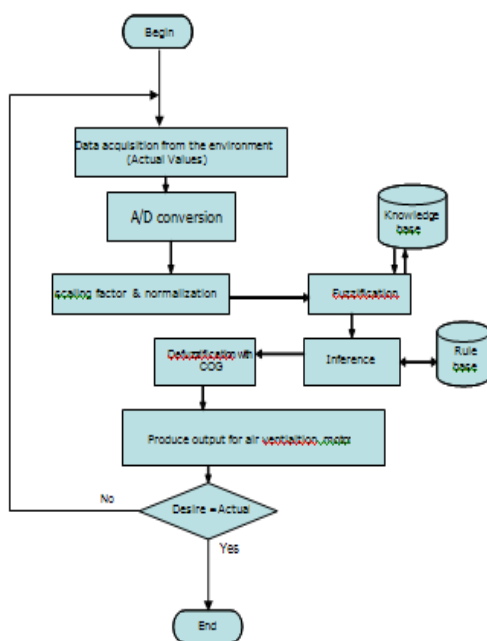

Figure 4. Flow Chart of Indoor Room Temperature Control System

4.2.1. Value Assignment of Fuzzy Logic Control

(a) Input Membership Functions

The temperature is define by triangular input membership functions with seven linguistic variables, labelde Normal (N), Normal Warm (NW), Warm (W), Warm High (WH), High (H), Very High (VH), Very Very High (VVH), had their membership tuning center values at 25, 28, 30, 32, 34, 36, 38 respectively. The universe of discourse for $T(t)$ is normalized from 24 to 38 .

The fan speed rate $F(t)$ is defined by triangular input membership functions with seven linguistic variables, labeled Very Very Slow (VVS), Very Slow (VS), Slow (S), Medium (M), Large (L), Very Large (VL), Very Very Large (VVL) had their ,membership tuning center valres at 30, 40, 50, 60, 70, 80, 90, 100 respectively. The universe of discourse for $F(t)$ is normalized from 30 to 100.

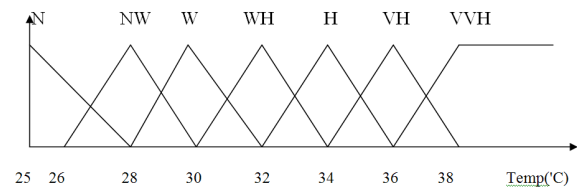

Figure 5. Membership function of input 1 (Temperature sensor)

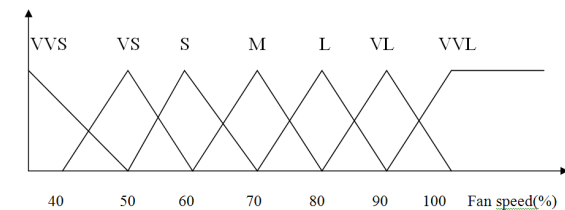

Figure 6. Membership function of input 2 (fan speed)

(b) Output Membership Function

The fuzzy put put variable, the control output $y(t)$ is defined by triangular membership functions with seven linguistic variables , labeled Very Very Slow (VVS), Very Slow (VS), Slow (S), Medium (M), Large (L), Very Large (VL), Very Very Large (VVL) had their ,membership tuning center valres at 30, 40, 50, 60, 70, 80, 90, 100 respectively. The universe of discourse for $y(t)$ is normalized from 30 to 100.

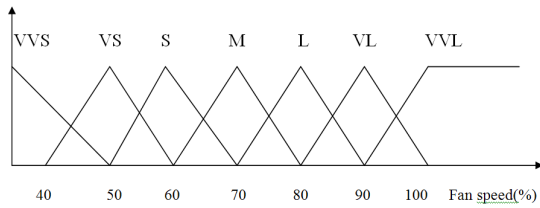

Figure 7. Membership function of output (new fan speed)

4.3. Experimental Result

PIC16F877A can operate with 20MHZ, fuzzy logic controller deployed for indoor room temperature control use the 4MHZ oscillator clock. Temperature sensor circuits are sensed the data from the environment. Temperature sensor can operate between 25C to 38C change but it can be operate in the real world hasn't limitation. The PIC16F877A is produced output to DC motor using fuzzy logic. DC motor is operate between the range of 500rpm to 0rpm.

Table 2. Experimental Result of the System

No	Temperature Range	Fan Speed
1	Temp >38°C	500 rpm
2	37°C, 36°C	4600 rpm
3	35°C, 34°C	4400 rpm
4	33°C, 32°C	4100 rpm
5	31°C, 30°C	3900 rpm
6	29°C, 28°C	3700 rpm
7	27°C, 26°C	3300 rpm
8	Temp <25°C	0 rpm

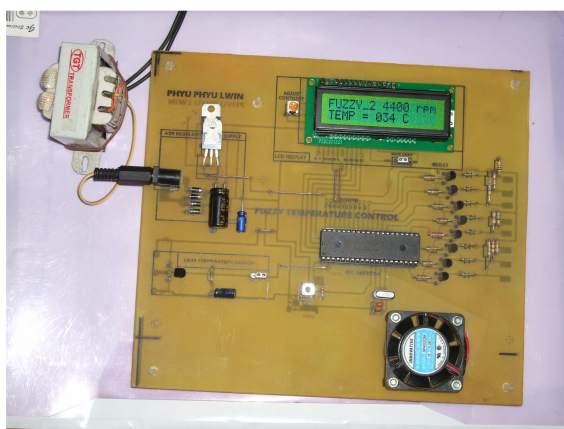

Figure 8. Photograph of the System

5. Conclusion and Further Extension

In the indoor room temperature control system, it cooperates with PIC16F877A and driven to DC motor with fuzzy logic. Fuzzy logic must be accurately and completely good performance for rather than other logics.

5.1 Conclusion

Indoor room temperature control system has demonstrated the implementation of FLC for with DC motor for a smart home system. The FLC is easy to implement and require a small amount of in expensive components in compact size. In this system, this PIC accept inputs through A/D pins (AN0) and can operate for output by using fuzzy logic control system. This PIC sends the output through the RD0-RD7 pin to the DC motor. If inputs from the sensors are changed the output pin change for the DC motor is speed changed. In this system, LM35DZ sensor has limitation range 4V to 30V.

The PIC-based fuzzy logic control systems are widely used in industrial process control applications due to their compactness, cost effectiveness and embedded capabilities. It is very useful for any measurement and control applications within a temperature range between 25°C and 38°C. This system is suitable indoor room temperature control for all homes, apartments, schools, workshops, highway tunnel, ship yards and etc. Accuracy of the fuzzy logic controller is found satisfactory.

5.2 Limitations and Further Extension

Although the temperature range of the controller is between 25°C and 38°C, it can be extended to control temperature range and by changing type of sensor; i.e using thermocouple instead of semiconductor IC sensor because some types of thermocouples can sense above 1000°C. This system cannot sense for DC motor processing speed and cannot process for Interrupt processing.

In this system, set points are determined by control program. Control program is burned into microcontroller by using Visual Basic software and convert to assembly codes and JDM programmer. Thus, these set points are fixed for one time burning. This system implemented with the open loop control system it can be extended with closed loop control system by using tachometer. This system will be implemented with AC motor for indoor room temperature control system.

The fuzzy logic controller implemented in this thesis used the conventional control technique. So, other control technique such as Neural Network

and Fuzzy logic can be used as further extension to achieve good performance and response.

REFERENCES

- [1] Changjiuf Zhou: Fuzzy_arithmetic_based Lyapunov synthesis in their design of stable fuzzy controllers. Int..J.Appl math.Comput.Sci, 2002, Vol, No.3, 411-421.
- [2] Data sheet of PIC16FXX2 High Performance, Enhanced FLASH Microcontrollers with 10-bit A/D,2002
<http://www.microchip.com>
- [3] Hnin Pwint Phyu, ADAPTIVE FUZZY SPEED CONTROL SYSTEM FOR DC MOTOR.2000
- [4] J.Klir,George/Yuan Bo:Fuzzy Set And Fuzzy Logic Theory and Applications,Prentice Hall of India Private Limited,New Delhi-110001,2000.
- [5] Mike Anderson,Maintaing an Unstable Equilibrium Through the Use of A Fuzzy Logic Controller.
- [6] Nandar Kay Thi,PIC Based Automatic Fire Fighting System using Fuzzy Logic Control,M.C.Tech,2009.
- [7] Nan Khin Natha Soe,Fuzzy Logic Temperature Control System,M.C.Tech,2004.
- [8] Timothy, J.Ross,University of New Mexicou USA.Fuzzy Logic with engineering application.